

Description

The SMBJ-Q series is designed specifically to protect sensitive electronic equipment from voltage transients induced by lightning and other transient voltage events. For surface mounted applications in order to optimize board space.

Features

- Halogen free and RoHS compliant
- Low profile package
- Built-in strain relief design
- Low inductance
- Excellent clamping capability
- 600W peak pulse power capability at 10/1000 μ s waveform, repetition rate (duty cycle): 0.01%
- Fast response time
- Typical I_R less than 1 μ A above 10V devices
- Peak 260 $^{\circ}$ C high temperature Reflow Soldering withstanding
- Meet MSL level1, per J-STD-020
- IEC-61000-4-2 ESD 30kV(Air), 30kV (Contact)
- Unit Weight: 0.10g
- AEC-Q101 Qualified

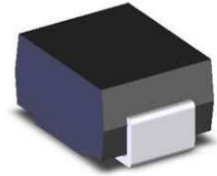

Applications

TVS components are ideal for the protection of I/O Interfaces, VCC bus and other vulnerable circuits used in telecom, computer, Industrial and consumer electronic applications.

Maximum Ratings and Characteristics ($T_A=25^{\circ}\text{C}$)

Rating	Symbol	Value
Peak pulse power dissipation at 10/1000 μ s waveform (Note1, Note2, Fig.1)	P_{PPM}	600W
Peak pulse current of at 10/1000 μ s waveform (Note 1, Fig.3)	I_{PPM}	See Table(A)
Steady state power dissipation at $T_A=50^{\circ}\text{C}$ (Fig.5)	$P_{M(AV)}$	5.0W
Maximum Instantaneous Forward Voltage at 50A for Unidirectional Only	V_F	3.5V/5.0V
Peak forward surge current, 8.3ms single half sine-wave superimposed on rated load, (JEDEC Method) (Note3, Fig.6)	I_{FSM}	100A
Operating junction and Storage Temperature Ranges	T_J, T_{STG}	-55 $^{\circ}\text{C}$ to +150 $^{\circ}\text{C}$
Typical thermal resistance junction to lead	$R_{\theta JL}$	20 $^{\circ}\text{C}/\text{W}$
Typical thermal resistance junction to ambient	$R_{\theta JA}$	100 $^{\circ}\text{C}/\text{W}$

Notes:1. Non-repetitive current pulse, per Fig.3 and derating above $T_A=25^{\circ}\text{C}$ per Fig.2.

2. Each terminal is surface Mounted on the 5.0mm \times 5.0mm (0.03mm thick) copper pads.

3. 8.3ms single half sine-wave or equivalent square wave, duty cycle=4 pulses per minutes maximum.

4. $V_F<3.5\text{V}$ for single die parts and $V_F<5.0\text{V}$ for stacked-die parts.

Electrical Characteristics (T_A=25°C)

Part Number		Device Marking Code		Reverse Stand-Off Voltage	Breakdown Voltage @I _T		Test Current	Maximum Clamping Voltage @I _{PP}	Peak Pulse Current	Reverse Leakage @V _R
Uni.	Bi.	Uni.	Bi.	V _R (V)	V _{B Min.} (V)	V _{B Max.} (V)	I _T (mA)	V _C (V)	I _{PP} (A)	I _R (μA)
SMBJ5.0A-Q	SMBJ5.0CA-Q	KE	AE	5.0	6.40	7.00	10	9.2	65.3	800
SMBJ6.0A-Q	SMBJ6.0CA-Q	KG	AG	6.0	6.67	7.37	10	10.3	58.3	800
SMBJ6.5A-Q	SMBJ6.5CA-Q	KK	AK	6.5	7.22	7.98	10	11.2	53.6	500
SMBJ7.0A-Q	SMBJ7.0CA-Q	KM	AM	7.0	7.78	8.60	10	12.0	50.0	200
SMBJ7.5A-Q	SMBJ7.5CA-Q	KP	AP	7.5	8.33	9.21	1	12.9	46.6	100
SMBJ8.0A-Q	SMBJ8.0CA-Q	KR	AR	8.0	8.89	9.83	1	13.6	44.2	50
SMBJ8.5A-Q	SMBJ8.5CA-Q	KT	AT	8.5	9.44	10.40	1	14.4	41.7	20
SMBJ9.0A-Q	SMBJ9.0CA-Q	KV	AV	9.0	10.00	11.10	1	15.4	39.0	10
SMBJ10A-Q	SMBJ10CA-Q	KX	AX	10.0	11.10	12.30	1	17.0	35.3	5
SMBJ11A-Q	SMBJ11CA-Q	KZ	AZ	11.0	12.20	13.50	1	18.2	33.0	1
SMBJ12A-Q	SMBJ12CA-Q	LE	BE	12.0	13.30	14.70	1	19.9	30.2	1
SMBJ13A-Q	SMBJ13CA-Q	LG	BG	13.0	14.40	15.90	1	21.5	28.0	1
SMBJ14A-Q	SMBJ14CA-Q	LK	BK	14.0	15.60	17.20	1	23.2	25.9	1
SMBJ15A-Q	SMBJ15CA-Q	LM	BM	15.0	16.70	18.50	1	24.4	24.6	1
SMBJ16A-Q	SMBJ16CA-Q	LP	BP	16.0	17.80	19.70	1	26.0	23.1	1
SMBJ17A-Q	SMBJ17CA-Q	LR	BR	17.0	18.90	20.90	1	27.6	21.8	1
SMBJ18A-Q	SMBJ18CA-Q	LT	BT	18.0	20.00	22.10	1	29.2	20.6	1
SMBJ20A-Q	SMBJ20CA-Q	LV	BV	20.0	22.20	24.50	1	32.4	18.6	1
SMBJ22A-Q	SMBJ22CA-Q	LX	BX	22.0	24.40	26.90	1	35.5	16.9	1
SMBJ24A-Q	SMBJ24CA-Q	LZ	BZ	24.0	26.70	29.50	1	38.9	15.5	1
SMBJ26A-Q	SMBJ26CA-Q	ME	CE	26.0	28.90	31.90	1	42.1	14.3	1
SMBJ28A-Q	SMBJ28CA-Q	MG	CG	28.0	31.10	34.40	1	45.4	13.3	1
SMBJ30A-Q	SMBJ30CA-Q	MK	CK	30.0	33.30	36.80	1	48.4	12.4	1
SMBJ33A-Q	SMBJ33CA-Q	MM	CM	33.0	36.70	40.60	1	53.3	11.3	1
SMBJ36A-Q	SMBJ36CA-Q	MP	CP	36.0	40.00	44.20	1	58.1	10.4	1
SMBJ40A-Q	SMBJ40CA-Q	MR	CR	40.0	44.40	49.10	1	64.5	9.3	1
SMBJ43A-Q	SMBJ43CA-Q	MT	CT	43.0	47.80	52.80	1	69.4	8.7	1
SMBJ45A-Q	SMBJ45CA-Q	MV	CV	45.0	50.00	55.30	1	72.7	8.3	1
SMBJ48A-Q	SMBJ48CA-Q	MX	CX	48.0	53.30	58.90	1	77.4	7.8	1
SMBJ51A-Q	SMBJ51CA-Q	MZ	CZ	51.0	56.70	62.70	1	82.4	7.3	1
SMBJ54A-Q	SMBJ54CA-Q	NE	DE	54.0	60.00	66.30	1	87.1	6.9	1

Electrical Characteristics (T_A=25°C)

Part Number		Device Marking Code		Reverse Stand-Off Voltage	Breakdown Voltage @I _T		Test Current	Maximum Clamping Voltage @I _{PP}	Peak Pulse Current	Reverse Leakage @V _R
Uni.	Bi.	Uni.	Bi.	V _R (V)	V _{B Min.} (V)	V _{B Max.} (V)	I _T (mA)	V _C (V)	I _{PP} (A)	I _R (μA)
SMBJ58A-Q	SMBJ58CA-Q	NG	DG	58.0	64.40	71.20	1	93.6	6.5	1
SMBJ60A-Q	SMBJ60CA-Q	NK	DK	60.0	66.70	73.70	1	96.8	6.2	1
SMBJ64A-Q	SMBJ64CA-Q	NM	DM	64.0	71.10	78.60	1	103.0	5.9	1
SMBJ70A-Q	SMBJ70CA-Q	NP	DP	70.0	77.80	86.00	1	113.0	5.3	1
SMBJ75A-Q	SMBJ75CA-Q	NR	DR	75.0	83.30	92.10	1	121.0	5.0	1
SMBJ78A-Q	SMBJ78CA-Q	NT	DT	78.0	86.70	95.80	1	126.0	4.8	1
SMBJ85A-Q	SMBJ85CA-Q	NV	DV	85.0	94.40	104.0	1	137.0	4.4	1
SMBJ90A-Q	SMBJ90CA-Q	NX	DX	90.0	100.0	111.0	1	146.0	4.1	1
SMBJ100A-Q	SMBJ100CA-Q	NZ	DZ	100.0	111.00	123.00	1	162.0	3.7	1
SMBJ110A-Q	SMBJ110CA-Q	PE	EE	110.0	122.0	135.0	1	177.0	3.4	1
SMBJ120A-Q	SMBJ120CA-Q	PG	EG	120.0	133.0	147.0	1	193.0	3.1	1
SMBJ130A-Q	SMBJ130CA-Q	PK	EK	130.0	144.0	159.0	1	209.0	2.9	1
SMBJ150A-Q	SMBJ150CA-Q	PM	EM	150.0	167.0	185.0	1	243.0	2.5	1
SMBJ160A-Q	SMBJ160CA-Q	PP	EP	160.0	178.0	197.0	1	259.0	2.3	1
SMBJ170A-Q	SMBJ170CA-Q	PR	ER	170.0	189.0	209.0	1	275.0	2.2	1
SMBJ180A-Q	SMBJ180CA-Q	PT	ET	180.0	201.0	222.0	1	292.0	2.1	1
SMBJ190A-Q	SMBJ190CA-Q	PA	EC	190.0	211.0	233.0	1	308.0	2.0	1
SMBJ200A-Q	SMBJ200CA-Q	PV	EV	200.0	224.0	247.0	1	324.0	1.9	1
SMBJ210A-Q	SMBJ210CA-Q	PB	ED	210.0	237.0	263.0	1	340.0	1.8	1
SMBJ220A-Q	SMBJ220CA-Q	PX	EX	220.0	246.0	272.0	1	356.0	1.7	1
SMBJ250A-Q	SMBJ250CA-Q	PZ	EZ	250.0	279.0	309.0	1	405.0	1.5	1
SMBJ300A-Q	SMBJ300CA-Q	QE	FE	300.0	335.0	371.0	1	486.0	1.3	1
SMBJ350A-Q	SMBJ350CA-Q	QG	FG	350.0	391.0	432.0	1	567.0	1.1	1
SMBJ400A-Q	SMBJ400CA-Q	QK	FK	400.0	447.0	494.0	1	648.0	0.9	1
SMBJ440A-Q	SMBJ440CA-Q	QM	FM	440.0	492.0	543.0	1	713.0	0.9	1
SMBJ480A-Q	SMBJ480CA-Q	QP	FP	480.0	536.5	592.9	1	780.0	0.8	1
SMBJ500A-Q	SMBJ500CA-Q	QR	FR	500.0	558.0	618.0	1	810.0	0.8	1
SMBJ510A-Q	SMBJ510CA-Q	QT	FT	510.0	575.2	628.4	1	828.0	0.73	1
SMBJ550A-Q	SMBJ550CA-Q	QU	FU	550.0	614.0	680.0	1	891.0	0.68	1
SMBJ600A-Q	SMBJ600CA-Q	QV	FV	600.0	670.0	741.0	1	971.0	0.62	1

Ratings and Characteristic Curves ($T_A=25^\circ\text{C}$)

Figure 1. Peak Pulse Power Rating Curve

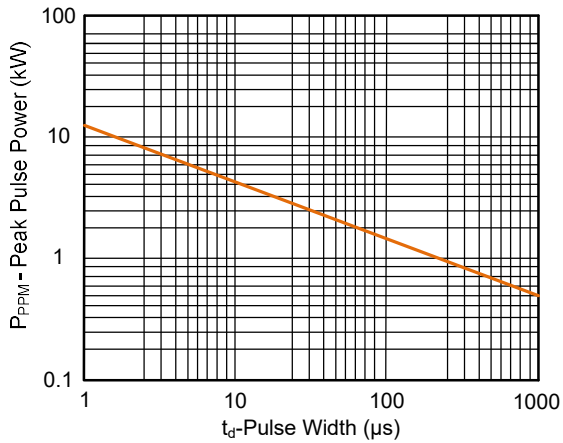

Figure 2. Pulse Derating Curve

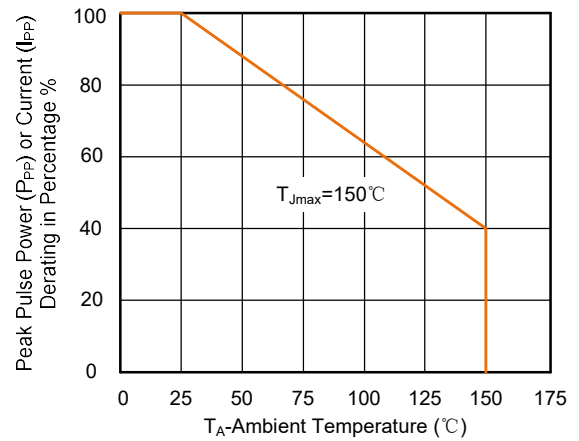

Figure 3. Pulse Waveform

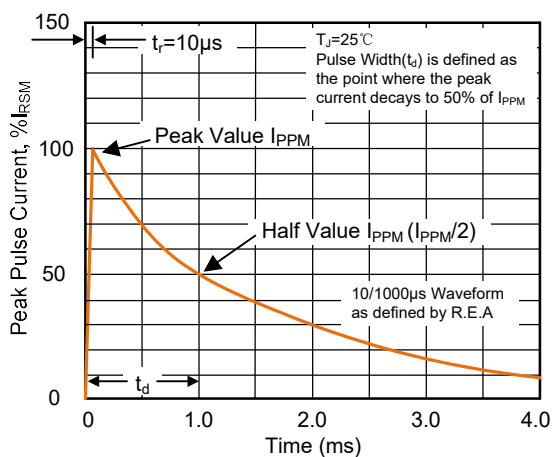

Figure 4. Typical Junction Capacitance

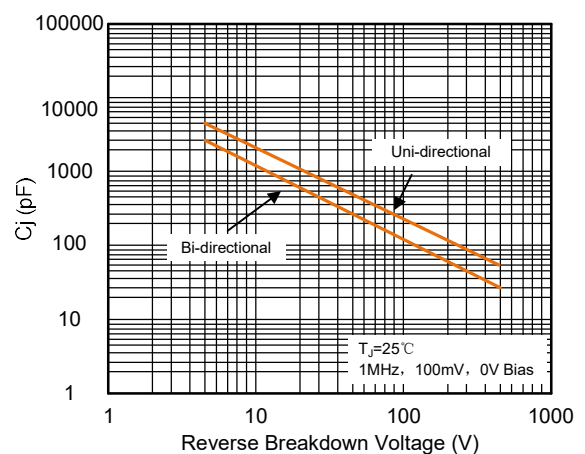

Figure 5. Steady State Power Dissipation Derating Curve

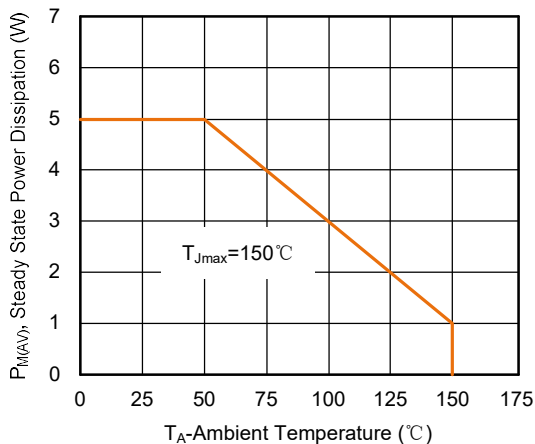
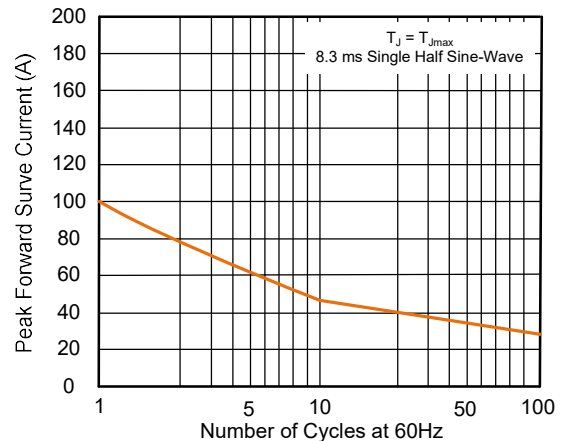
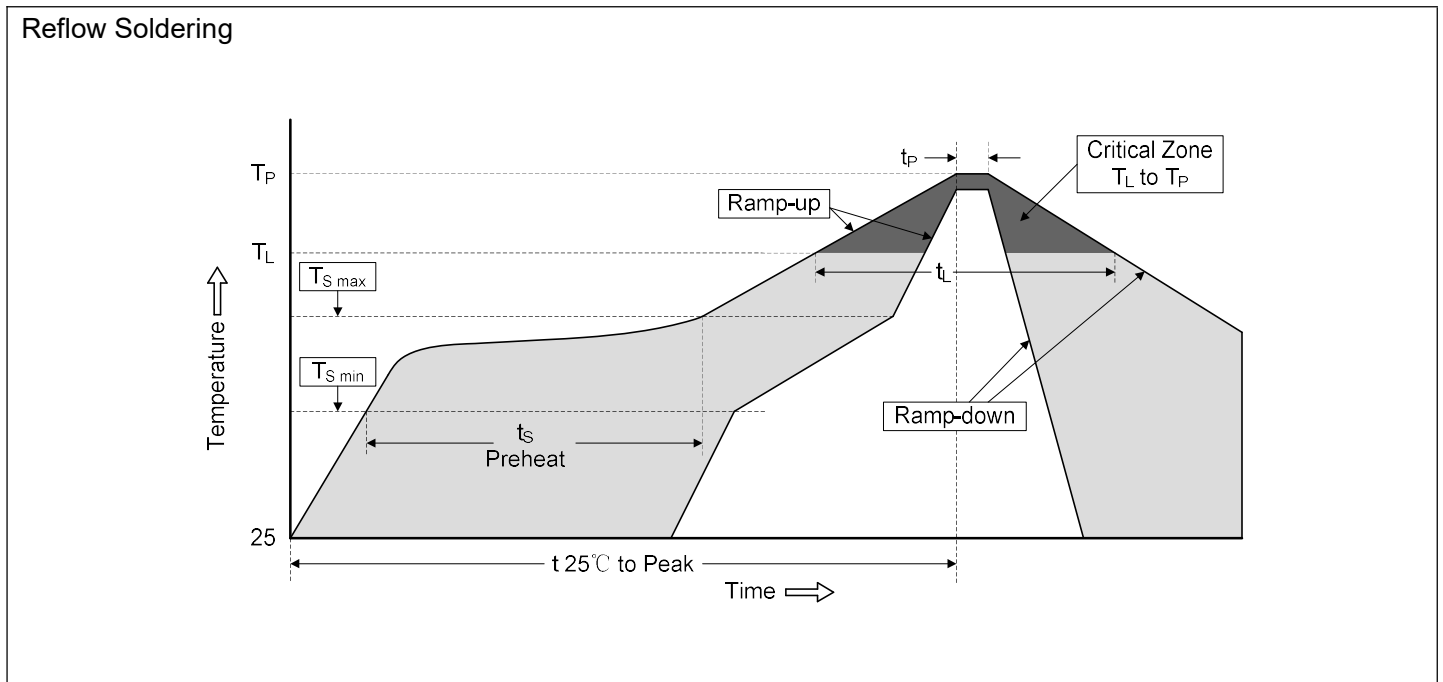

Figure 6. Maximum Non-Repetitive Forward Surge Current Uni-Directional Only



Soldering Parameters



Profile Feature	Pb-Free Assembly
Average ramp-up rate (T_L to T_P)	3°C/second max.
Preheat -Temperature Min ($T_{S\ min}$) -Temperature Max ($T_{S\ max}$) -Time (min to max) (t_s)	150°C 200°C 60-180 seconds
$T_{S\ max}$ to T_L -Ramp-up Rate	3°C/second max.
Time maintained above: -Temperature (T_L) -Time (t_L)	217°C 60-150 seconds
Peak Temperature (T_P)	260°C
Time within 5°C of actual Peak Temperature (t_p)	20-40 seconds
Ramp-down Rate	6°C/second max.
Time 25°C to Peak Temperature	8 minutes max.

Part Number Code and Marking Code

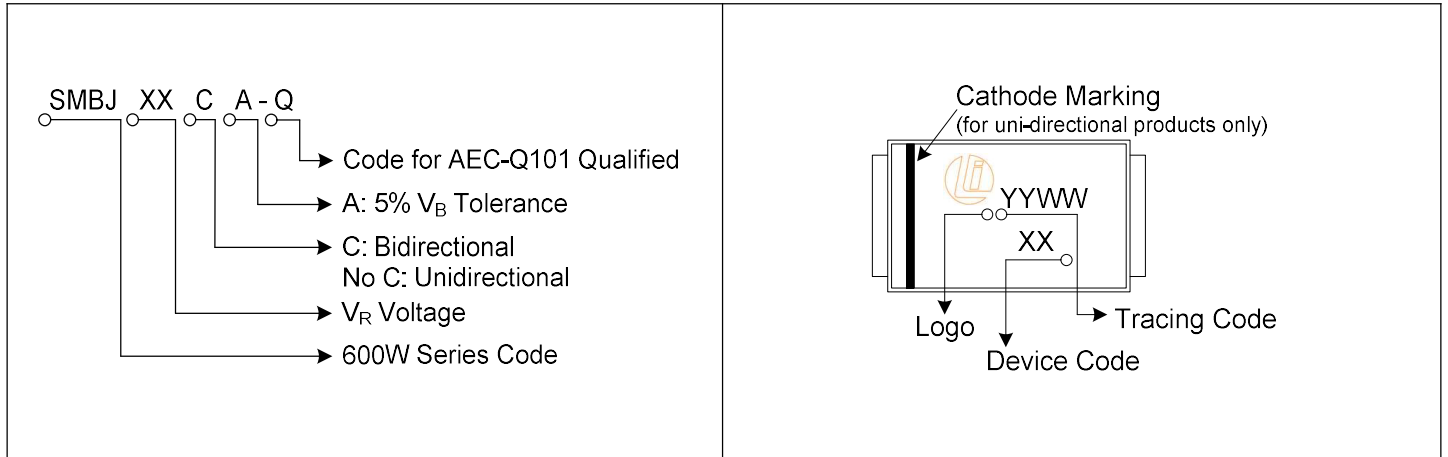

Dimensions (SMB/DO-214AA)

Symbol	Millimeters		Inches	
	Min.	Max.	Min.	Max.
A	1.930	2.200	0.076	0.086
B	4.060	4.750	0.160	0.187
C	3.300	3.940	0.130	0.155
D	2.160	2.650	0.085	0.104
E	0.760	1.520	0.030	0.060
F	-	0.203	-	0.008
G	5.210	5.590	0.205	0.220
H	0.152	0.305	0.006	0.012
I	2.260	-	0.089	-
J	2.160	-	0.085	-
K	-	2.740	-	0.107

Packaging Specification

Tape

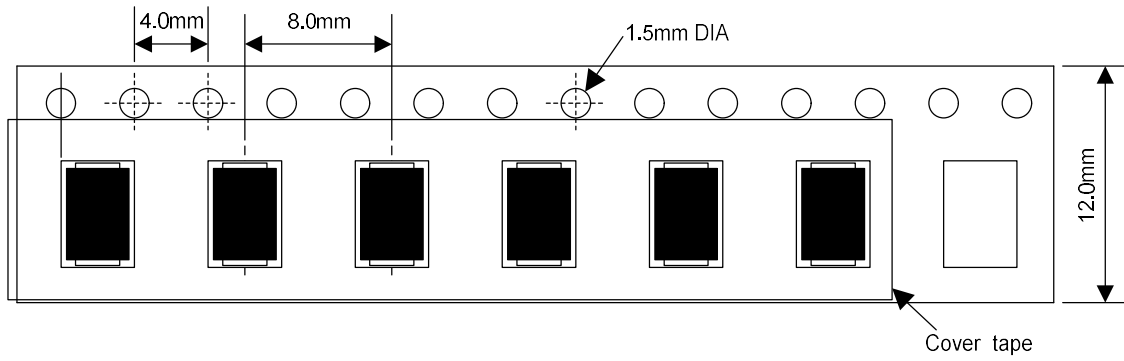

For Uni-Devices

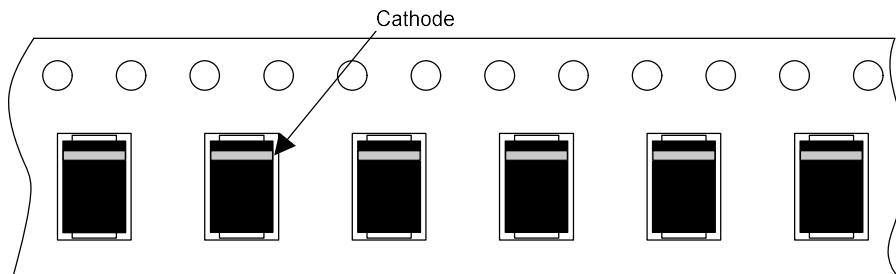

13 Inches Reel

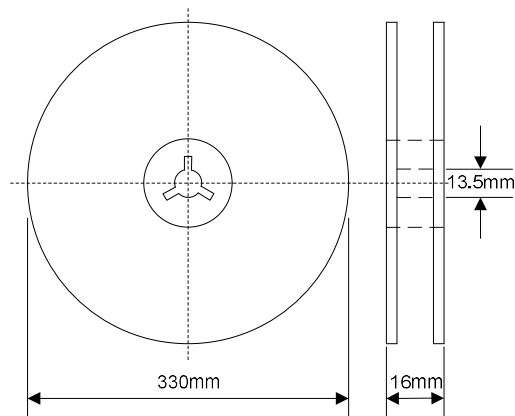

Quantity: 3000pcs/reel