

Description

The 30KP series is designed specifically to protect sensitive electronic equipment from voltage transients induced by lightning and other transient voltage events.

Features

- Halogen free and RoHS compliant
- Glass passivated junction
- Low incremental surge resistance
- Excellent clamping capability
- 30000W peak pulse power capability at 10/1000 μ s waveform, repetition rate (duty cycle): 0.05%
- Fast response time
- Typical I_R less than 2 μ A above 64V devices
- High Temperature soldering guaranteed: 265 $^{\circ}$ C/10 seconds/.375", (9.5mm) lead length, 5lbs (2.3kg) tension
- Plastic package has underwriters laboratory flammability 94V-0
- Meet MSL level1, per J-STD-020
- IEC-61000-4-2 ESD 30kV(Air), 30kV (Contact)
- Unit Weight: 2.46g



Applications

TVS components are ideal for the protection of I/O Interfaces, VCC bus and other vulnerable circuits used in telecom, computer, Industrial and consumer electronic applications.

Maximum Ratings and Characteristics ($T_A=25^{\circ}$ C)

Rating	Symbol	Value
Peak pulse power dissipation at 10/1000 μ s waveform (Note1, Fig.1)	P_{PPM}	30000W
Peak pulse current of at 10/1000 μ s waveform (Note 1, Fig.3)	I_{PPM}	See Table(A)
Steady state power dissipation at $T_L=75^{\circ}$ C (Fig.5)	$P_{M(AV)}$	8.0W
Peak forward surge current, 8.3ms single half sine-wave superimposed on rated load, (JEDEC Method) (Note2, Fig.6)	I_{FSM}	400A
Operating junction and Storage Temperature Ranges	T_J, T_{STG}	-55 $^{\circ}$ C to +150 $^{\circ}$ C
Typical thermal resistance junction to lead	$R_{\theta JL}$	8 $^{\circ}$ C/W
Typical thermal resistance junction to ambient	$R_{\theta JA}$	40 $^{\circ}$ C/W

Notes:1. Non-repetitive current pulse, per Fig.3 and derating above $T_A=25^{\circ}$ C per Fig.2.

2. 8.3ms single half sine-wave or equivalent square wave, duty cycle=4 pulses per minutes maximum.

Electrical Characteristics (T_A=25°C)

Part Number		Reverse Stand-Off Voltage	Breakdown Voltage @I _T		Test Current	Maximum Clamping Voltage @I _{PP}	Peak Pulse Current	Reverse Leakage @V _R
Uni.	Bi.	V _R (V)	V _{B Min.} (V)	V _{B Max.} (V)	I _T (mA)	V _C (V)	I _{PP} (A)	I _R (μA)
30KP28A	30KP28CA	28.0	31.28	34.57	50	50.0	606.0	2500
30KP30A	30KP30CA	30.0	33.51	37.04	50	55.2	548.9	2000
30KP33A	30KP33CA	33.0	36.90	40.78	50	58.5	517.9	1500
30KP36A	30KP36CA	36.0	40.20	44.43	50	61.8	490.3	1000
30KP39A	30KP39CA	39.0	43.60	48.19	20	67.2	450.9	800
30KP42A	30KP42CA	42.0	46.90	51.84	10	72.0	420.8	200
30KP43A	30KP43CA	43.0	48.00	53.05	10	73.0	415.1	150
30KP45A	30KP45CA	45.0	50.30	55.59	5	77.4	391.5	30
30KP48A	30KP48CA	48.0	53.60	59.24	5	81.6	371.3	15
30KP51A	30KP51CA	51.0	57.00	63.00	5	86.4	350.7	10
30KP54A	30KP54CA	54.0	60.30	66.65	5	91.4	331.5	5
30KP58A	30KP58CA	58.0	64.80	71.62	5	92.4	327.9	5
30KP60A	30KP60CA	60.0	67.00	74.05	5	102.0	297.1	5
30KP64A	30KP64CA	64.0	71.50	79.03	5	104.0	291.3	5
30KP66A	30KP66CA	66.0	73.70	81.46	5	107.0	283.2	2
30KP70A	30KP70CA	70.0	78.20	86.43	5	109.0	278.0	2
30KP71A	30KP71CA	71.0	79.30	87.65	5	111.5	271.7	2
30KP72A	30KP72CA	72.0	80.40	88.86	5	114.0	265.8	2
30KP75A	30KP75CA	75.0	83.80	92.62	5	119.4	253.8	2
30KP78A	30KP78CA	78.0	87.10	96.27	5	129.0	234.9	2
30KP84A	30KP84CA	84.0	93.80	103.67	5	139.2	217.7	2
30KP90A	30KP90CA	90.0	100.50	111.08	5	146.4	207.0	2
30KP96A	30KP96CA	96.0	107.20	118.48	5	156.0	194.2	2
30KP102A	30KP102CA	102.0	113.90	125.89	5	165.6	183.0	2
30KP108A	30KP108CA	108.0	120.60	133.29	5	175.2	172.9	2

Electrical Characteristics (T_A=25°C)

Part Number		Reverse Stand-Off Voltage	Breakdown Voltage @I _T		Test Current	Maximum Clamping Voltage @I _{PP}	Peak Pulse Current	Reverse Leakage @V _R
Uni.	Bi.	V _R (V)	V _{B Min.} (V)	V _{B Max.} (V)	I _T (mA)	V _C (V)	I _{PP} (A)	I _R (μA)
30KP120A	30KP120CA	120.0	134.00	148.11	5	194.4	155.9	2
30KP132A	30KP132CA	132.0	147.40	162.92	5	213.0	142.3	2
30KP144A	30KP144CA	144.0	160.80	177.73	5	223.2	135.8	2
30KP150A	30KP150CA	150.0	167.60	185.24	5	233.4	129.8	2
30KP156A	30KP156CA	156.0	174.30	192.65	5	245.0	123.7	2
30KP160A	30KP160CA	160.0	178.70	197.51	5	252.6	120.0	2
30KP168A	30KP168CA	168.0	187.70	207.46	5	272.4	111.2	2
30KP170A	30KP170CA	170.0	189.90	209.89	5	275.0	110.2	2
30KP180A	30KP180CA	180.0	201.10	222.27	5	290.4	104.3	2
30KP198A	30KP198CA	198.0	221.20	244.48	5	319.8	94.7	2
30KP216A	30KP216CA	216.0	241.30	266.70	5	348.6	86.9	2
30KP240A	30KP240CA	240.0	268.10	296.32	5	387.0	78.3	2
30KP258A	30KP258CA	258.0	288.20	318.54	5	416.4	72.8	2
30KP260A	30KP260CA	260.0	290.40	320.97	5	416.0	72.8	2
30KP270A	30KP270CA	270.0	301.60	333.35	5	436.2	69.5	2
30KP280A	30KP280CA	280.0	312.80	345.73	5	464.0	65.3	2
30KP288A	30KP288CA	288.0	321.70	355.56	5	469.9	64.5	2
30KP300A	30KP300CA	300.0	334.00	367.40	5	484.0	62.0	2
30KP320A	30KP320CA	320.0	357.40	391.40	5	530.0	57.2	2
30KP350A	30KP350CA	350.0	391.00	428.10	5	567.0	53.4	2
30KP360A	30KP360CA	360.0	402.10	440.30	5	640.0	47.3	2

Ratings and Characteristic Curves ($T_A=25^\circ\text{C}$)

Figure 1. Peak Pulse Power Rating Curve

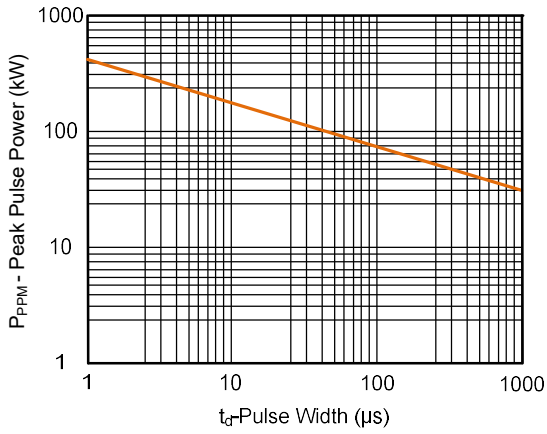

Figure 2. Pulse Derating Curve

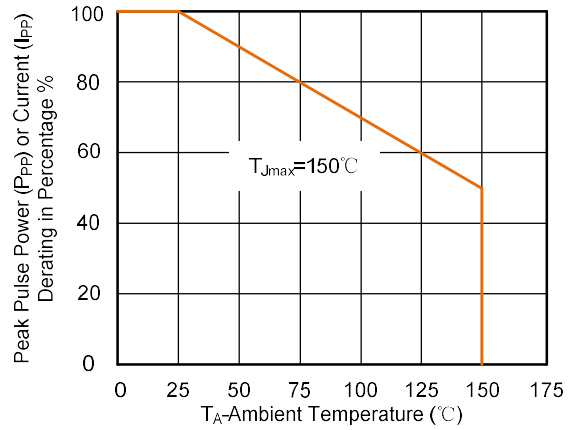

Figure 3. Pulse Waveform

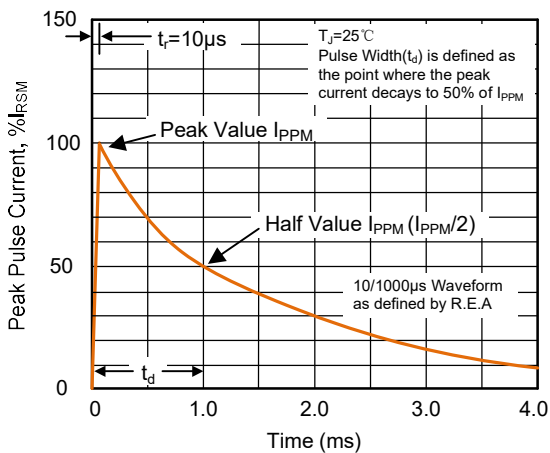

Figure 4. Typical Junction Capacitance

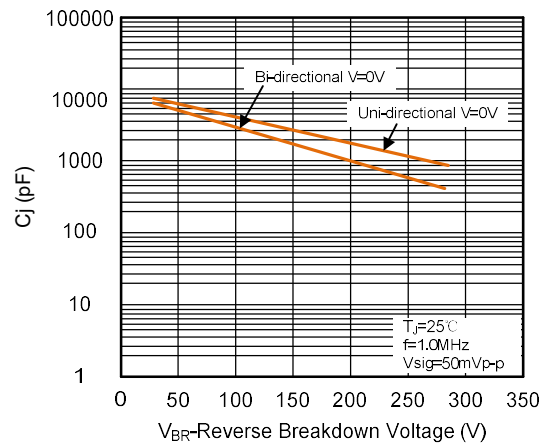

Figure 5. Steady State Power Dissipation Derating Curve

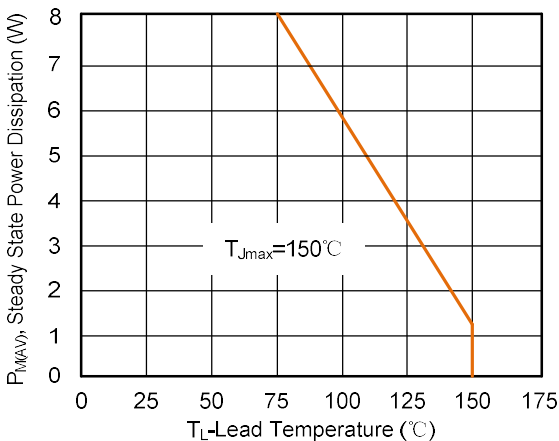
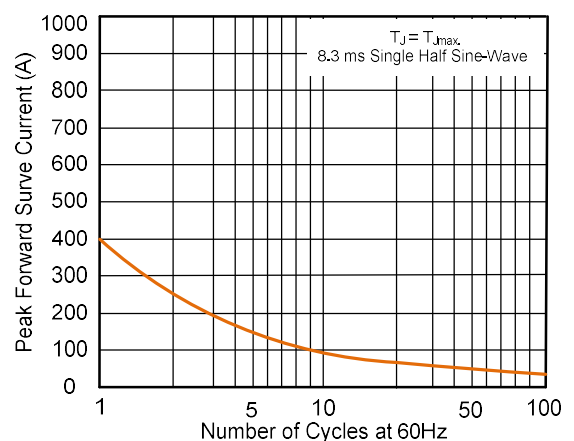
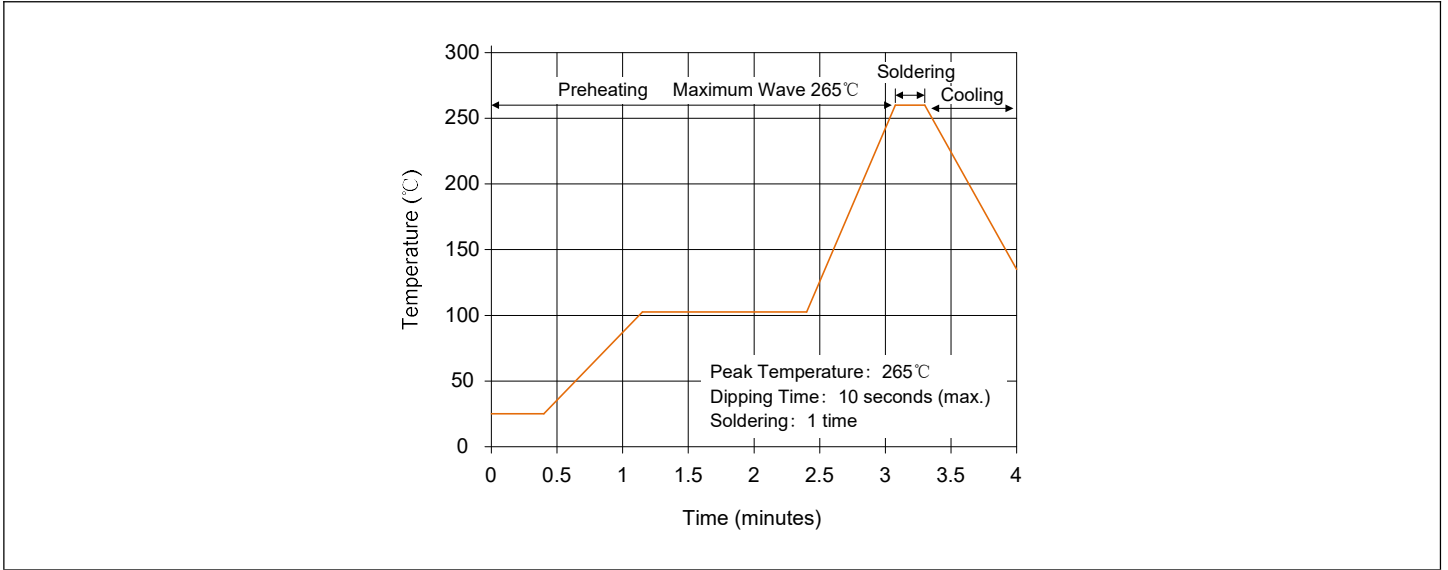

Figure 6. Maximum Non-Repetitive Forward Surge Current Uni-Directional Only



Wave Soldering



Part Number Code and Marking Code

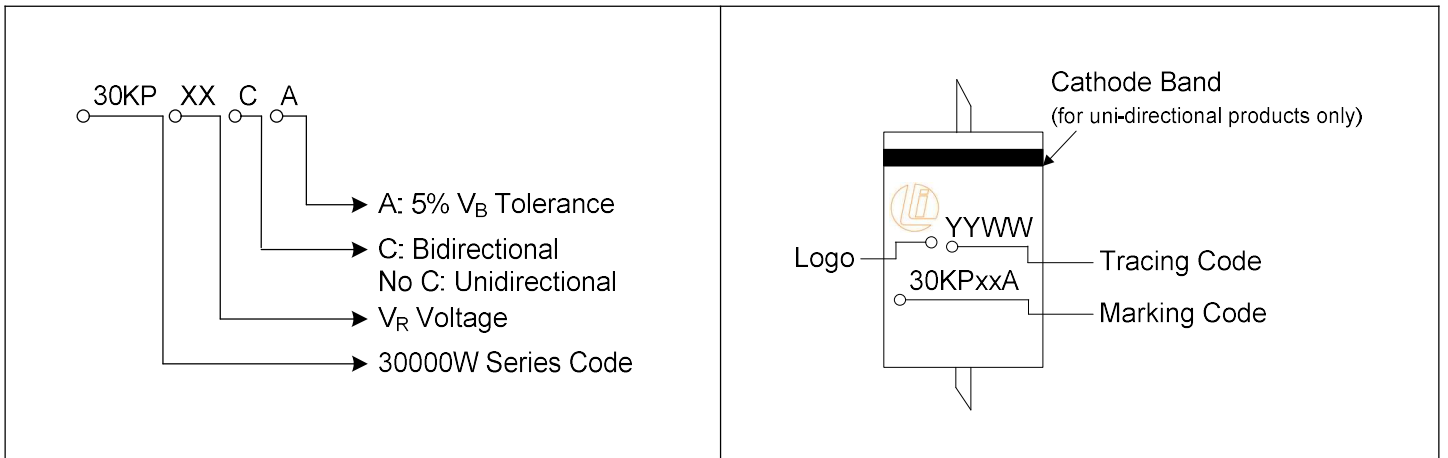

Dimensions (P600)

The diagram shows the dimensions of the diode: A (lead length), B (body length), C (body height), and d (lead thickness).

Symbol	Millimeters		Inches	
	Min.	Max.	Min.	Max.
A	25.40	-	1.000	-
B	8.60	9.10	0.340	0.360
C	8.60	9.10	0.340	0.360
d	1.19	1.35	0.047	0.053

Packaging Specification

Tape

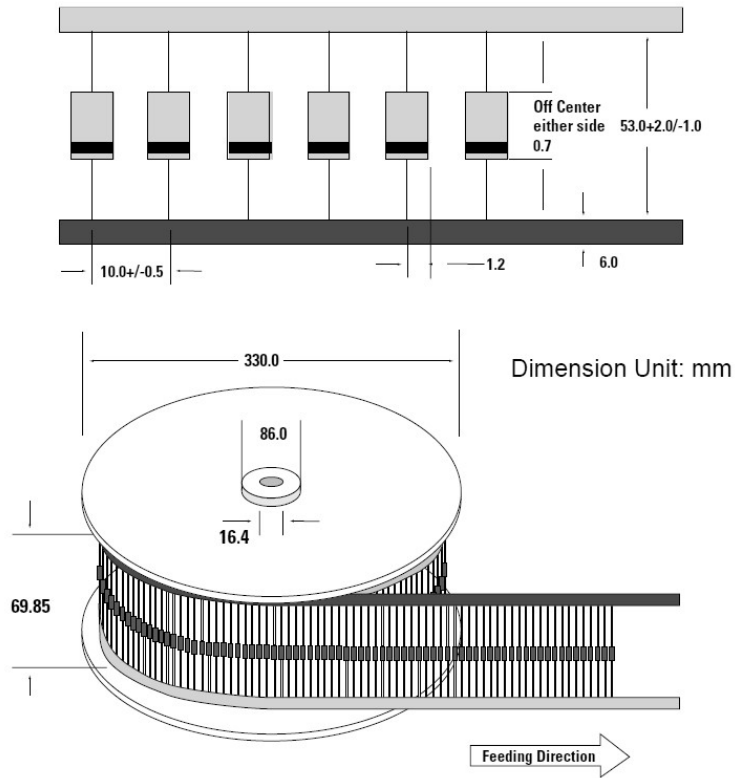

Quantity: 800pcs/reel

Box

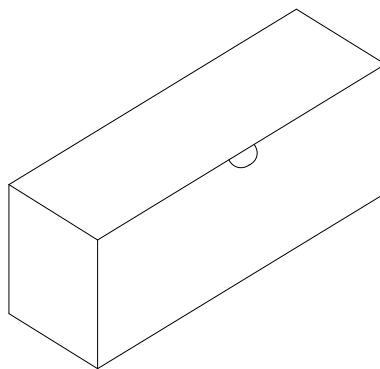

Quantity: 300pcs/box